

T-LINE

AUTOMATIC SLIDING
DOOR



T-LINE AUTOMATIC SLIDING DOOR



T-LINE is TAU's automation for pedestrian sliding doors. It is conceived for busy environments, where a fast opening speed is required, as well as for domestic environments, where softer and more controlled movements are needed. Thanks to its simple and elegant design, the silent T-LINE automation can easily match any type of house furniture.

T-LINE automatic sliding door is easy to install and control, thanks to some smart devices such as the self-support beam and its cover.

Every automation system must be completed with opening, safety and control devices according to the existing legislation.

TECHNICAL FEATURES

T-LINE TECHNICAL FEATURES

DESCRIPTION	1 LEAF T-LINE	DOUBLE LEAF T-LINE
Door opening width	700 ÷ 3100 mm	900 ÷ 3100 mm
Max leaf weight	150 Kg	130 Kg +130 Kg
Max automation sizes	160 x 120 x max. length 6500 mm	
Power	120 VA	
Power supply	230 V - 50Hz	
DC door operator power supply	48 V dc with encoder	
Outer accessories power supply	24 Vdc - 24 Vac	
Opening speed	80 cm/sec per leaf	
Closing speed	80 cm/sec per leaf	
Adjustable pause time	0 ÷ 32 sec.	
Self-adjustment of the pause time	Yes	
Reduced winter opening	standard 75% off opening width	
Operating temperature	-15°C ÷ +55°C	
Degree of protection	IP 22	
Duty cycle	100%	
Number of manoeuvres	1.000.000 manoeuvres test	
Safety test	Radar test function available as per EN 16005 requirements	
Interlock system	Available. A second TAU automatic door can only be opened after the closing of the first one	
Separate opening/closure inputs	Yes	
Type of use	Residential - Commercial - Industrial	



Types of opening

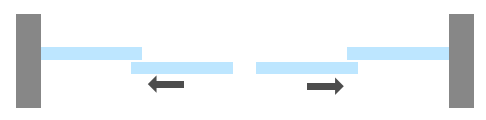

DOUBLE LEAF

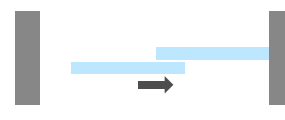

SINGLE LEAF
opening to the right

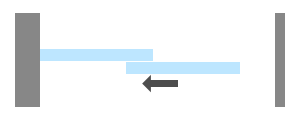

SINGLE LEAF
opening to the left

COMPONENTS OF T-LINE AUTOMATIC DOOR



1

SIDE HANDLE UNLOCKING DEVICE

(optional)

It is possible to unlock the automation manually thanks to the simple and intuitive side handle. It can be placed to the left or to the right of the aluminium beam.



COMPACT SIZES

Easy to fit in any environment thanks to its small sizes (only 120 mm height and 157,5 mm width).

2



3



SILENT MOVEMENT

A track that lays on an anti-vibration gasket ensures a silent and flowing movement of the door.

The track can be replaced once worn out.

An additional sound control gasket has been placed between the beam and its cover in order to further reduce the impact of the vibrations.

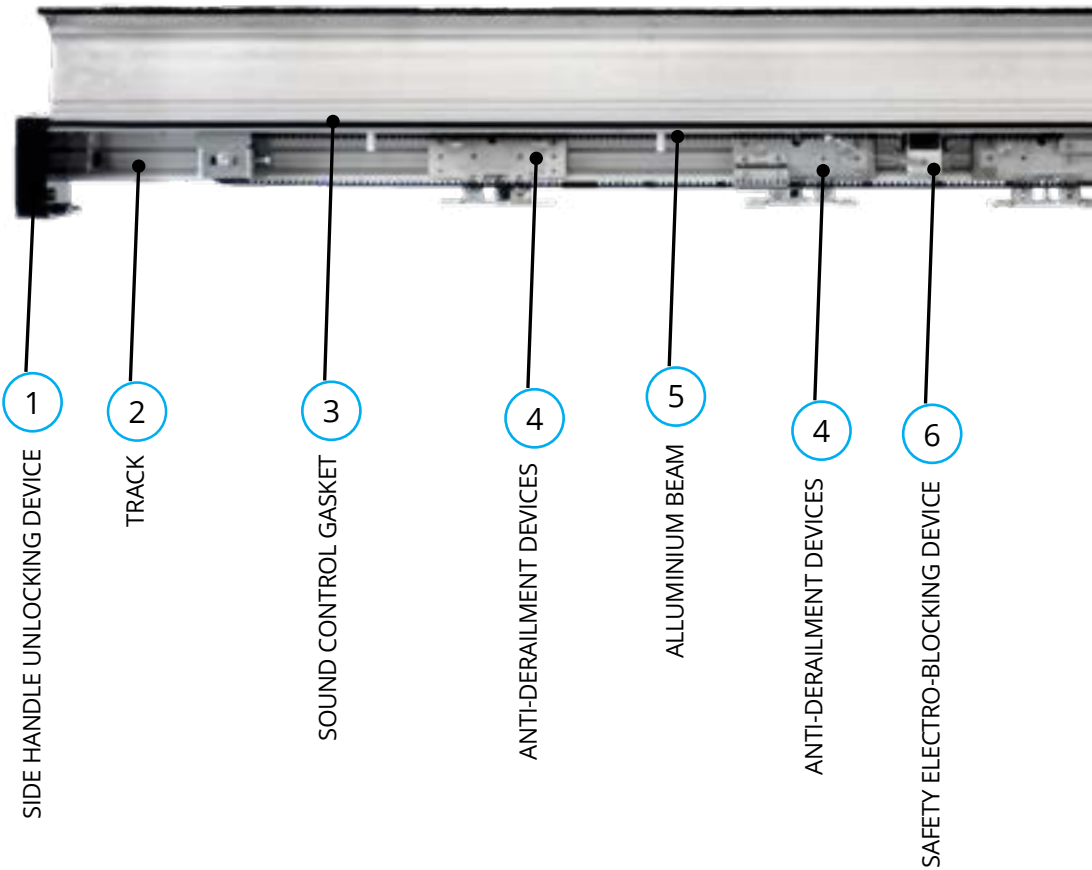

9



CONTROL BOARD

The control board is conceived to meet any operating need. Easy to programme, it can be set through simple trimmers and dip switches or through the optional digital keypad. In accordance to EN-16005 standards.

4



ANTI-DERAILMENT DEVICES

The steady double wheel track rollers with a third anti-derailment wheel are conceived to sustain leaves that weigh up to 150 kg.

EASY AND QUICK INSTALLATION

Thanks to the practical aluminium anchor template, the beam can quickly and easily be fixed just by one person.

5



4

ANTI-DERAILMENT DEVICES

7

ALUMINIUM BEAM COVER

8

MOTOR WITH ENCODER

9

CONTROL BOARD



6

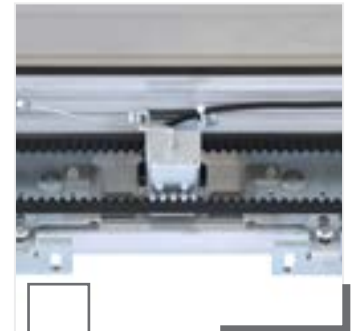

SAFETY ELECTRO-BLOCKING DEVICE

Manual emergency opening device simple and easy to activate thanks to the central or side handle. The optional electro-locking device ensures the closing of the door.

EVERYTHING UNDER CONTROL

A steady DC gate operator with optical encoder ensures and controls the movement of the door.



8

7

PRACTICAL

The aluminium beam cover can easily be opened. It can also remain lifted up to make the maintenance of the automation easier.



ACCESSORIES FOR T-LINE AUTOMATIC DOOR



S-10T-LINETD **DIGITAL KEYPAD**

Elegant and practical 4-button digital keypad that allows a quick and easy set up of the automatic door.



S-10T-LINESELF **T-LINE PROGRAMME SWITCH**

Allows to choose among 5 different operating programmes: always open, winter opening, both directions, always open, exit only and exit blocked.



S-10DOORTL **OPENING DEVICE**

Opening device with touchless microwave sensor that allows to open the door only by placing your hand close to it. This device is the best solution to ensure the automatic opening to doors that cannot be equipped with a radar.



S-10DOORRAD2 **DUAL FUNCTION RADAR**

Infrared radar to activate and secure t-line automatic door, compliant to EN16005 standards.

This device is provided with the open/close function to activate the automation. It can also work as a safety photocell, thus making the installation of the automation easier.



S-10DOORRAD **ACTIVATION RADAR**

Infrared activation radar provided with the open/close function. It also allows to activate the safety function.



S-10DOORRADM **TWO-WAY MICROWAVE RADAR**

4 m range radar. Its large detection distance allows the prompt opening of the doors when people or carts are quickly approaching.



S-10DOORRADMU **ONE-WAY MICROWAVE RADAR**

It detects people's direction flow. For example, when installed on a door next to the sidewalk, the radar detects people's direction flow and will make the automation open only if someone is moving in a perpendicular way to the door.



S-10DOORRAD/STA
NARROW-FIELD RADAR

Infrared active narrow field radar for side safety. It secures the space occupied by the leaf during the opening operation.



S10-DOORFOTOG
PHOTOCELLS

Set of safety photocells that can be installed inside the automatic door's frame. They ensure the safety of the installation without changing the design of the door.

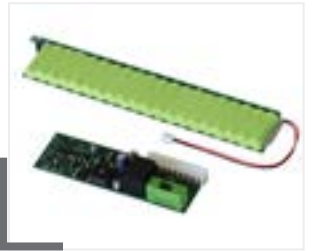

S-10T-LINEBATT
AUTOMATION WITHOUT POWER CUT

Thanks to the optional back up battery kit, the door opens even in case of a power cut. The charge control board and the battery kit can also be installed afterwards.



P-10T-LINEANT10 / P-10T-LINEANT15 / P-10T-LINEANT20
SUPPORT KIT FOR FRAMED LEAVES

Support kit for framed leaves that makes it easier to fix the leaf of the door to the carriage wheels. Available in different sizes.

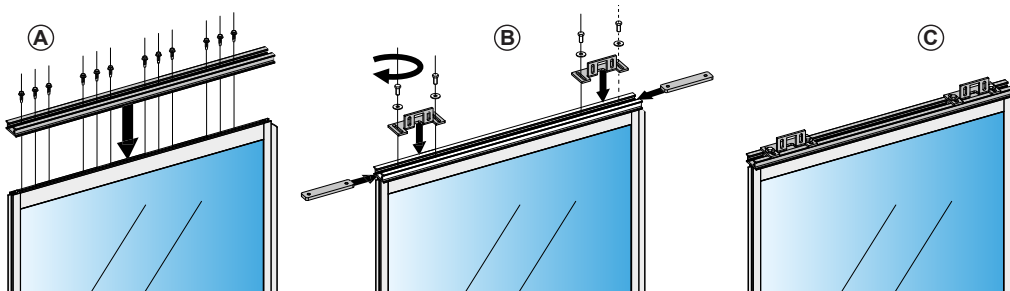

How to install the support kit for framed leaf



S-10DOORCRIS10 / S-10DOORCRIS15
SUPPORT KIT FOR UNFRAMED LEAVES

Support kit for unframed crystal leaves.

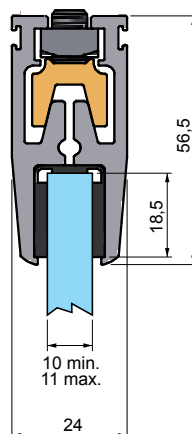

How to install the support kit for leaf + sizes



S-10T-LINE1240

SLIDING PLATE FOR CRYSTAL LEAF

Accessory for crystal leaves to be fastened to the ground in order to prevent the leaf from swinging during its movement.

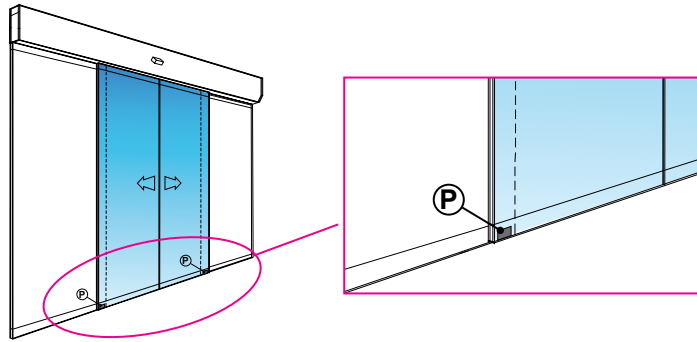

How to anchor the sliding plate



S-10T-LINE1250

SLIDING PLATE FOR FRAMED LEAF

Accessory for framed leaves to be fastened to the ground in order to prevent the leaf from swinging during its movement.

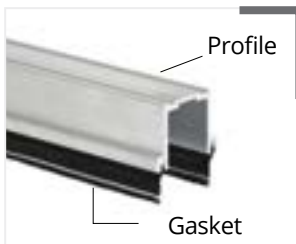

S- 10T-LINEPROFI

LOWER ALUMINUM PROFILE

2 m aluminum bar to be installed in the lower part of the framed leaf. It can secure the sliding of the leaf.

S- 10T-LINESPA

BRUSH SEAL

4 m brush seal to be installed in the lower part of the leaf as a draft stopper.



S-10T-LINEBLOCF2

SIDE SAFETY ELECTROMECHANICAL LOCK

The electromechanical lock ensures the door's closure. The manual unlock is easy to activate through the side handle when the emergency manual opening is required.



S-10T-LINEBLOCL

CENTRAL SAFETY ELECTROMECHANICAL LOCK

The electromechanical lock ensures the door's closure. Its design is discreet and the device is easy to activate when the manual emergency opening is required.



S-10T-LINEART

T-LINE COVER OPENING KIT

This kit makes the access to the automation easier, thus avoiding problems when you need to remove the cover but the distance between the ceiling and the automation is too short to open it like you would normally do.



T-line cover opening kit after the installation

TECHNICAL DRAWINGS

Minimum dimensions for opening the cover with disassembly

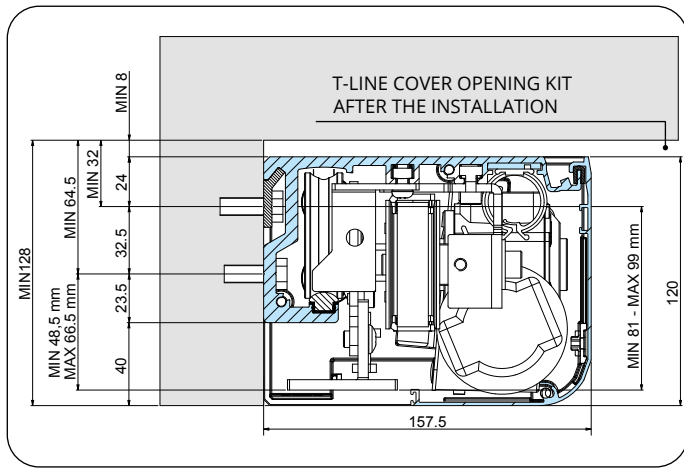

Minimum dimensions for cover opening with articulation kit

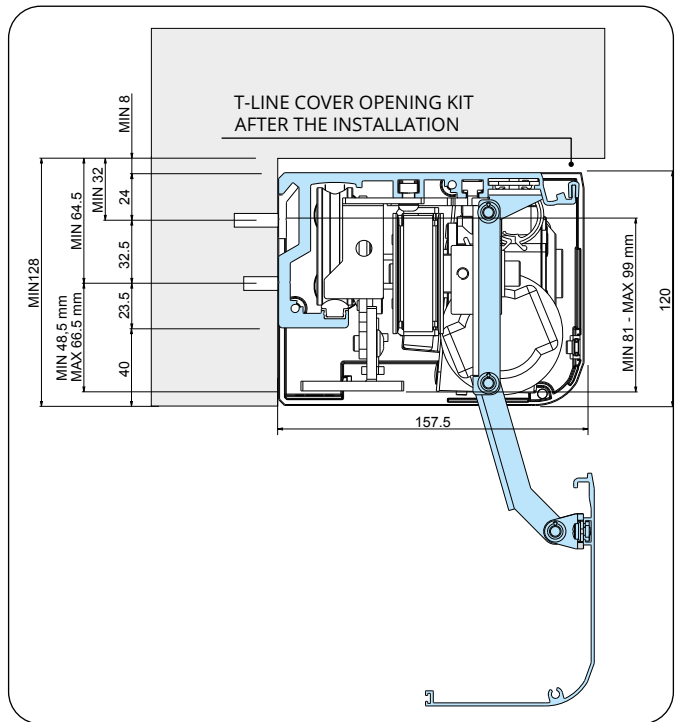

Minimum dimensions for opening the casing upwards

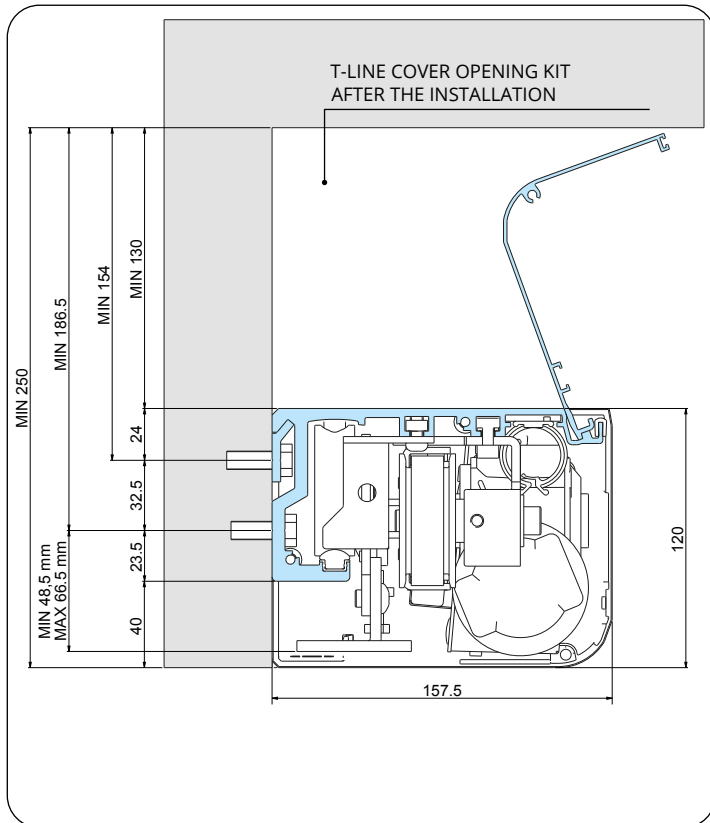

Maximum range of carriage adjustment

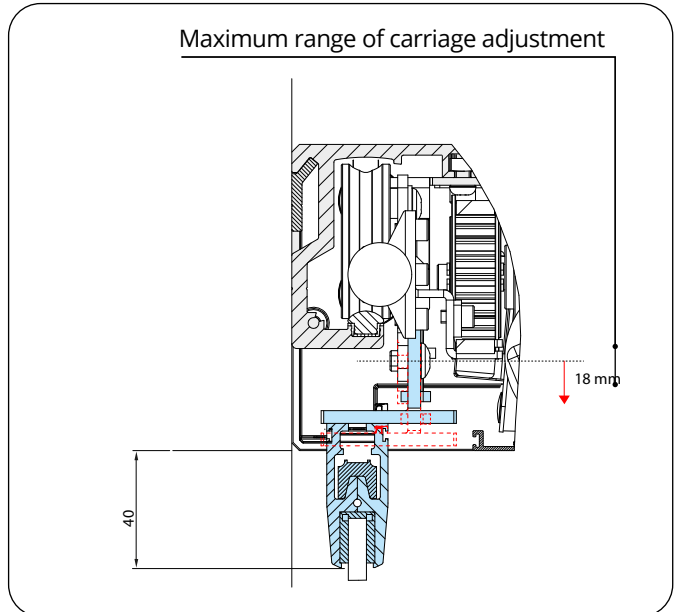

T-LINE INSTALLATION KIT



Features:

The components to assemble the door (beam, cover and so on) are supplied separately. Cutting and assembling operations are carried out by the customer. It is the best solution for customers that need to quickly fulfil orders of tailor-made doors.

Pros:

- competitive costs
- increased flexibility
- eliminates the need to stock complete door packages
- logistics optimization
- prompt delivery to the end-user of a customized door package



T-LINEKIT1.150

Single leaf sliding door opener (max 150 kg)

T-LINEKIT2.130

Double leaf sliding door opener (max 130 + 130 kg)

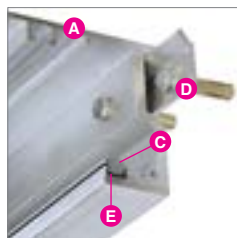
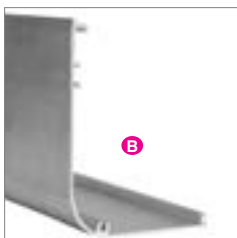

A) **S-10T-LINETRA65**

T-Line support beam L 6500 mm

B) **S-10T-LINECAR65**

T-Line front anodized aluminum cover profile L 6500 mm

C) **S-10T-LINEROT65**

T-Line track L 6500 mm

D) **S-10T-LINEANK65**

T-Line anchor template L 6500 mm

E) **S-10T-LINEANR**

Anti-vibration gasket for T-Line track. (200 m per pkg)

F) **M-0300000380**

Extruded rubber (100 m per pkg)

G) **S-10DOORCING**

Traction belt (50 m per pkg)



The beam and its cover can also be supplied in anodized aluminium (natural aluminium colour) upon request just before the order, with a 20% increase on the pricelist.

FRAME BREAK-OUT SYSTEM FOR SLIDING DOORS

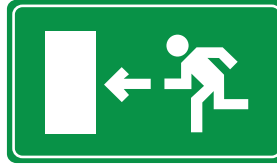

It is the best certified solution when the automatic door is also the only emergency exit.

Such system ensures the outward swing opening of the door when pushed.

LEGEND:

 = photocells S-10DOORFOTOH1

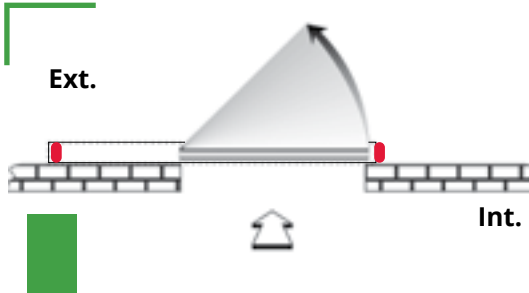

S-10DOORSF1M

Configuration: single sliding with fixed sidelight panels. Frame break-out system composed of 1 x break-out kit, 1 x upper profile 1300 mm, 1 x floor track 1400 mm. Specify right or left-hand (consult TAU for additional information)

Note: The automation is installed on the external wall of the building, so it must be protected from bad weather.

Additional components (to be purchased separately):
S-10DOORFOTOH1 Pair of safety photocells
S-10DOORSTF Pair of containers for additional safety photocells

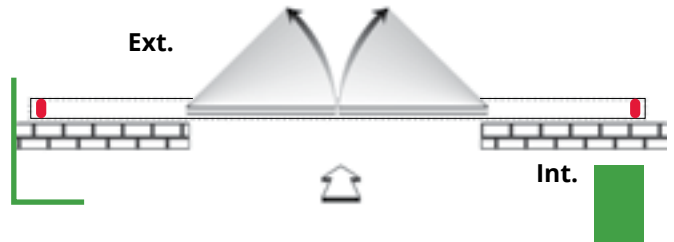

10DOORSF2M

Configuration: bi-parting with fixed sidelight panels. Frame break-out system composed of 2 x break-out kits, 2 x upper profiles 1300 mm, 2 x floor tracks 1400 mm

Note: The automation is installed on the external wall of the building, so it must be protected from bad weather.

Additional components (to be purchased separately):
S-10DOORFOTOH1 Pair of safety photocells
S-10DOORSTF Pair of containers for additional safety photocells

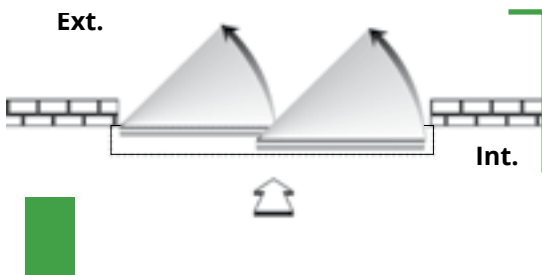

S-10DOORSF2MF

Configuration: single sliding with break-out sidelight panel. Frame break-out system composed of 1 x break-out kit, 1 x upper profile 1300 mm, 1 x floor track 1400 mm, 1 x ball-lock, 1 x magnetic contact. Specify right or left-hand (consult TAU for additional information)

Additional components (to be purchased separately):
S-10DOORSQ2 Lock brackets to prevent opening from the outside (2 pcs)
S-10DOORCRN2 1 pair of hinges
S-10DOORGPS Cable sheath for photocell
S-10DOORGPS Retractable cable sheath for photocell

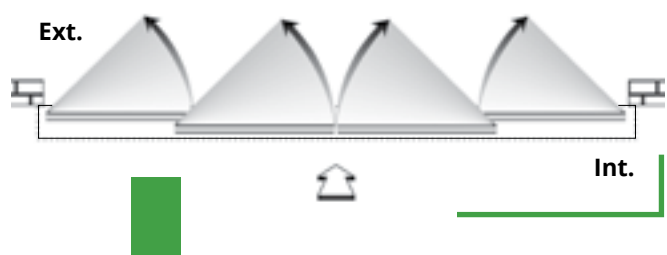

S-10DOORSF4MF

Configuration: bi-parting with break-out sidelight panels. Frame break-out system composed of 2 x break-out kits, 2 x upper profiles 1300 mm, 2 x floor tracks 1400 mm, 2 x ball-locks, 2 x magnetic contact

Additional components (to be purchased separately):
S-10DOORSQ4 Lock brackets to prevent opening from the outside (4 pcs)
S-10DOORCRN4 2 pairs of hinges
S-10DOORGPS2 Cable sheath for photocell (2 pcs)
S-10DOORGPS2 Retractable cable sheath for photocell (2 pcs)



Via Enrico Fermi, 43 - 36066 Sandrigo (VI) Italia
Tel +39 0444 750190 - Fax +39 0444 750376
info@tauitalia.com - www.tauitalia.com



 *Made in Italy*